

NLAS4053

Analog Multiplexer/ Demultiplexer

Triple 2:1 Analog Switch–Multiplexer Improved Process, Sub–Micron Silicon Gate CMOS

The NLAS4053 is an improved version of the MC14053 and MC74HC4053 fabricated in sub–micron Silicon Gate CMOS technology for lower $R_{DS(on)}$ resistance and improved linearity with low current. This device may be operated either with a single supply or dual supply up to ± 3.0 V to pass a 6 V_{PP} signal without coupling capacitors.

When operating in single supply mode, it is only necessary to tie V_{EE}, pin 7 to ground. For dual supply operation, V_{EE} is tied to a negative voltage, not to exceed maximum ratings. Pin for pin compatible with all industry standard versions of '4053.'

Features

- Improved $R_{DS(on)}$ Specifications
- Pin for Pin Replacement for MAX4053 and MAX4053A
 - One Half the Resistance Operating at 5.0 Volts
- Single or Dual Supply Operation
 - Single 3–5 Volt Operation, or Dual ± 3.0 Volt Operation
 - With V_{CC} of 3.0 to 3.3 V, Device Can Interface with 1.8 V Logic, No Translators Needed
 - Address and Inhibit Pins are Over–Voltage Tolerant and May Be Driven Up +6.0 V Regardless of V_{CC}
 - Greatly Improved Noise Margin Over MAX4053 and MAX4053A
- Improved Linearity Over Standard HC4053 Devices
- Popular SOIC and the Space Saving TSSOP Packages
- Pb–Free Packages are Available*



ON Semiconductor®

<http://onsemi.com>

MARKING DIAGRAMS

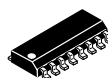

SOIC–16
D SUFFIX
CASE 751B

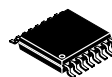
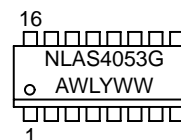

TSSOP–16
DT SUFFIX
CASE 948F

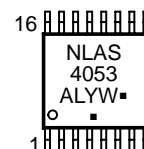

A = Assembly Location
L, WL = Wafer Lot
Y = Year
W, WW = Work Week
G = Pb–Free Package
▪ = Pb–Free Package
(Note: Microdot may be in either location)

ORDERING INFORMATION

See detailed ordering and shipping information in the package dimensions section on page 4 of this data sheet.

*For additional information on our Pb–Free strategy and soldering details, please download the ON Semiconductor Soldering and Mounting Techniques Reference Manual, SOLDERRM/D.

NLAS4053



Figure 1. Pin Connection
(Top View)

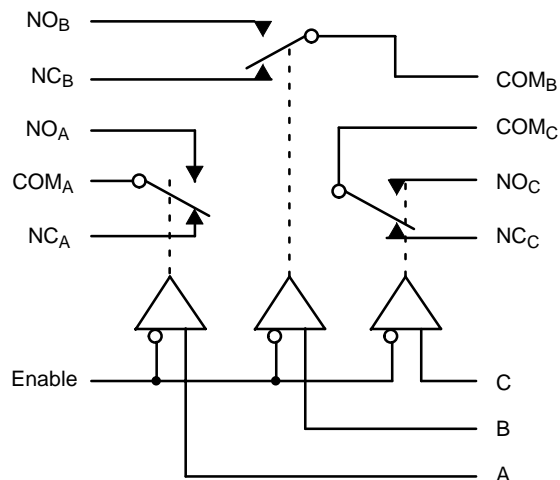

Figure 2. Logic Diagram

TRUTH TABLE

Inhibit	Address			ON SWITCHES*
	C	B	A	
1	X don't care	X don't care	X don't care	All switches open
0	0	0	0	COM _A -NC _A , COM _B -NC _B , COM _C -NC _C
0	0	0	1	COM _A -NO _A , COM _B -NC _B , COM _C -NC _C
0	0	1	0	COM _A -NC _A , COM _B -NO _B , COM _C -NC _C
0	0	1	1	COM _A -NO _A , COM _B -NO _B , COM _C -NC _C
0	1	0	0	COM _A -NC _A , COM _B -NC _B , COM _C -NO _C
0	1	0	1	COM _A -NO _A , COM _B -NC _B , COM _C -NO _C
0	1	1	0	COM _A -NC _A , COM _B -NO _B , COM _C -NO _C
0	1	1	1	COM _A -NO _A , COM _B -NO _B , COM _C -NO _C

*NO, NC, and COM pins are identical and interchangeable. Either may be considered an input or output; signals pass equally well in either direction.

NLAS4053

MAXIMUM RATINGS

Symbol	Parameter	Value	Unit
V_{EE}	Negative DC Supply Voltage (Referenced to GND)	-7.0 to +0.5	V
V_{CC}	Positive DC Supply Voltage (Note 1) (Referenced to GND) (Referenced to V_{EE})	-0.5 to +7.0 -0.5 to +7.0	V
V_{IS}	Analog Input Voltage	$V_{EE} - 0.5$ to $V_{CC} + 0.5$	V
V_{IN}	Digital Input Voltage (Referenced to GND)	-0.5 to 7.0	V
I	DC Current, Into or Out of Any Pin	± 50	mA
T_{STG}	Storage Temperature Range	-65 to +150	°C
T_L	Lead Temperature, 1 mm from Case for 10 Seconds	260	°C
T_J	Junction Temperature under Bias	+150	°C
θ_{JA}	Thermal Resistance SOIC TSSOP	143 164	°C/W
P_D	Power Dissipation in Still Air, SOIC TSSOP	500 450	mW
MSL	Moisture Sensitivity	Level 1	
F_R	Flammability Rating Oxygen Index: 30% – 35%	UL 94 V-0 @ 0.125 in	
V_{ESD}	ESD Withstand Voltage Human Body Model (Note 2) Machine Model (Note 3) Charged Device Model (Note 4)	> 2000 > 200 > 1000	V
$I_{LATCHUP}$	Latchup Performance Above V_{CC} and Below GND at 125°C (Note 5)	± 300	mA

Maximum ratings are those values beyond which device damage can occur. Maximum ratings applied to the device are individual stress limit values (not normal operating conditions) and are not valid simultaneously. If these limits are exceeded, device functional operation is not implied, damage may occur and reliability may be affected.

1. The absolute value of $V_{CC} \pm |V_{EE}| \leq 7.0$.
2. Tested to EIA/JESD22-A114-A.
3. Tested to EIA/JESD22-A115-A.
4. Tested to JESD22-C101-A.
5. Tested to EIA/JESD78.

RECOMMENDED OPERATING CONDITIONS

Symbol	Parameter	Min	Max	Unit
V_{EE}	Negative DC Supply Voltage (Referenced to GND)	-5.5	GND	V
V_{CC}	Positive DC Supply Voltage (Referenced to GND) (Referenced to V_{EE})	2.5 2.5	5.5 6.6	V
V_{IS}	Analog Input Voltage	V_{EE}	V_{CC}	V
V_{IN}	Digital Input Voltage (Note 6) (Referenced to GND)	0	5.5	V
T_A	Operating Temperature Range, All Package Types	-55	125	°C
t_r, t_f	Input Rise/Fall Time (Channel Select or Enable Inputs) $V_{CC} = 3.0\text{ V} \pm 0.3\text{ V}$ $V_{CC} = 5.0\text{ V} \pm 0.5\text{ V}$	0 0	100 20	ns/V

6. Unused digital inputs may not be left open. All digital inputs must be tied to a high-logic voltage level or a low-logic input voltage level.

NLAS4053

ORDERING INFORMATION

Device	Package	Shipping [†]
NLAS4053D	SOIC-16	48 Units / Rail
NLAS4053DG	SOIC-16 (Pb-Free)	48 Units / Rail
NLAS4053DR2	SOIC-16	2500 Tape & Reel
NLAS4053DR2G	SOIC-16 (Pb-Free)	2500 Tape & Reel
NLAS4053DT	TSSOP-16*	96 Units / Rail
NLAS4053DTG	TSSOP-16*	96 Units / Rail
NLAS4053DTR2	TSSOP-16*	2500 Tape & Reel
NLAS4053DTR2G	TSSOP-16*	2500 Tape & Reel

[†]For information on tape and reel specifications, including part orientation and tape sizes, please refer to our Tape and Reel Packaging Specifications Brochure, BRD8011/D.

*This package is inherently Pb-Free.

DC CHARACTERISTICS – Digital Section (Voltages Referenced to GND)

Symbol	Parameter	Condition	V _{CC} V	Guaranteed Limit			Unit
				-55 to 25°C	≤ 85°C	≤ 125°C	
V _{IH}	Minimum High-Level Input Voltage, Address and Inhibit Inputs		2.0	1.5	1.5	1.5	V
			3.0	2.1	2.1	2.1	
			4.5	3.15	3.15	3.15	
			5.5	3.85	3.85	3.85	
V _{IL}	Maximum Low-Level Input Voltage, Address and Inhibit Inputs		2.0	0.5	0.5	0.5	V
			3.0	0.9	0.9	0.9	
			4.5	1.35	1.35	1.35	
			5.5	1.65	1.65	1.65	
I _{IN}	Maximum Input Leakage Current, Address or Inhibit Inputs	V _{IN} = 6.0 or GND	0 V to 6.0 V	± 0.1	± 1.0	± 1.0	μA
I _{CC}	Maximum Quiescent Supply Current (per Package)	Channel Select, Enable and V _{IS} = V _{CC} or GND	6.0	4.0	40	80	μA

DC ELECTRICAL CHARACTERISTICS – Analog Section

Symbol	Parameter	Test Conditions	V _{CC} V	V _{EE} V	Guaranteed Limit			Unit
					-55 to 25°C	≤ 85°C	≤ 125°C	
R _{ON}	Maximum "ON" Resistance	V _{IN} = V _{IL} or V _{IH} V _{IS} = V _{EE} to V _{CC} I _S = 10 mA (Figures 4 thru 9)	3.0	0	86	108	120	Ω
			4.5	0	37	46	55	
			3.0	-3.0	26	33	37	
ΔR _{ON}	Maximum Difference in "ON" Resistance Between Any Two Channels in the Same Package	V _{IN} = V _{IL} or V _{IH} , V _{IS} = 2.0 V V _{IS} = 3.5 V I _S = 10 mA, V _{IS} = 2.0 V	3.0	0	15	20	20	Ω
			4.5	0	13	18	18	
			3.0	-3.0	10	15	15	
R _{flat(ON)}	COM-NO On-Resistance Flatness	V _{com} 1, 2, 3.5 V V _{com} -2, 0, 2 V I _S = 10 mA	4.5 3.0	0 -3.0	4 2	4 2	5 3	Ω
I _{NC(OFF)} I _{NO(OFF)}	Maximum Off-Channel Leakage Current	Switch Off V _{IN} = V _{IL} or V _{IH} V _{IO} = V _{CC} -1.0 V or V _{EE} +1.0 V (Figure 17)	6.0	0	0.1	5.0	100	nA
			3.0	-3.0	0.1	5.0	100	
I _{COM(ON)}	Maximum On-Channel Leakage Current, Channel- to-Channel	Switch On V _{IO} = V _{CC} -1.0 V or V _{EE} +1.0 V (Figure 17)	6.0	0	0.1	5.0	100	nA
			3.0	-3.0	0.1	5.0	100	

NLAS4053

AC CHARACTERISTICS (Input $t_r = t_f = 3$ ns)

Symbol	Parameter	Test Conditions	V _{CC} V	V _{EE} V	Guaranteed Limit				Unit
					-55 to 25°C		≤ 85°C	≤ 125°C	
					Min	Typ*			
t _{BBM}	Minimum Break-Before-Make Time	V _{IN} = V _{IL} or V _{IH} V _{IS} = V _{CC} R _L = 300 Ω, C _L = 35 pF (Figure 19)	3.0	0.0	1.0	6.5	–	–	ns
			4.5	0.0	1.0	5.0	–	–	
			3.0	-3.0	1.0	3.5	–	–	

*Typical Characteristics are at 25°C.

AC CHARACTERISTICS (C_L = 50 pF, Input $t_r = t_f = 3$ ns)

Symbol	Parameter	V _{CC} V	V _{EE} V	Guaranteed Limit						Unit	
				-55 to 25°C			≤ 85°C		≤ 125°C		
				Min	Typ	Max	Min	Max	Min		Max
t _{TRANS}	Transition Time (Address Selection Time) (Figure 18)	2.5 3.0 4.5 3.0	0 0 0 -3.0			40		45		50	ns
						28		30		35	
						23		25		30	
						23		25		28	
t _{ON}	Turn-on Time (Figures 14, 15, 20, and 21) Enable to N _O or N _C	2.5 3.0 4.5 3.0	0 0 0 -3.0			40		45		50	ns
						28		30		35	
						23		25		30	
						23		25		28	
t _{OFF}	Turn-off Time (Figures 14, 15, 20, and 21) Enable to N _O or N _C	2.5 3.0 4.5 3.0	0 0 0 -3.0			40		45		50	ns
						28		30		35	
						23		25		30	
						23		25		28	

		Typical @ 25°C, V _{CC} = 5.0 V		
C _{IN}	Maximum Input Capacitance, Select Inputs	8		pF
C _{NO} or C _{CNC}	Analog I/O	10		
C _{COM}	Common I/O	10		
C _(ON)	Feedthrough	1.0		

ADDITIONAL APPLICATION CHARACTERISTICS (GND = 0 V)

Symbol	Parameter	Condition	V _{CC} V	V _{EE} V	Typ	Unit
					25°C	
BW	Maximum On-Channel Bandwidth or Minimum Frequency Response	V _{IS} = ½ (V _{CC} - V _{EE}) Source Amplitude = 0 dBm (Figures 10 and 22)	3.0	0.0	145	MHz
			4.5	0.0	165	
			6.0	0.0	180	
			3.0	-3.0	180	
V _{ISO}	Off-Channel Feedthrough Isolation	f = 100 kHz; V _{IS} = ½ (V _{CC} - V _{EE}) Source = 0 dBm (Figures 12 and 22)	3.0	0.0	-93	dB
			4.5	0.0	-93	
			6.0	0.0	-93	
			3.0	-3.0	-93	
V _{ONL}	Maximum Feedthrough On Loss	V _{IS} = ½ (V _{CC} - V _{EE}) Source = 0 dBm (Figures 10 and 22)	3.0	0.0	-2	dB
			4.5	0.0	-2	
			6.0	0.0	-2	
			3.0	-3.0	-2	
Q	Charge Injection	V _{IN} = V _{CC} to V _{EE} , f _{IS} = 1 kHz, t _r = t _f = 3 ns R _{IS} = 0 Ω, C _L = 1000 pF, Q = C _L * ΔV _{OUT} (Figures 16 and 23)	5.0	0.0	9.0	pC
			3.0	-3.0	12	
THD	Total Harmonic Distortion THD + Noise	f _{IS} = 1 MHz, R _L = 10 KΩ, C _L = 50 pF, V _{IS} = 5.0 V _{PP} sine wave V _{IS} = 6.0 V _{PP} sine wave (Figure 13)	6.0	0.0	0.10	%
			3.0	-3.0	0.05	

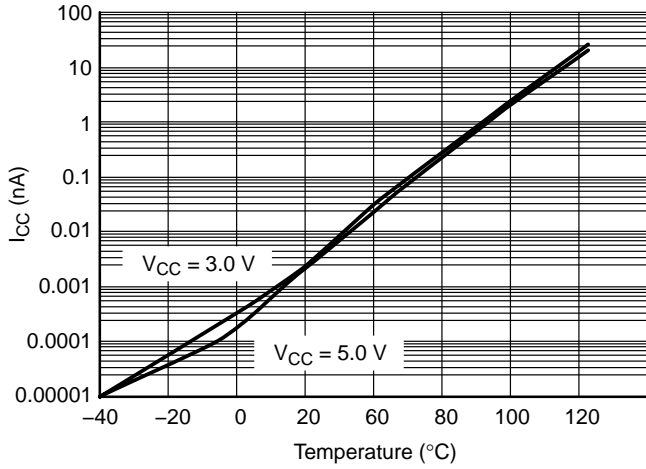

Figure 3. I_{CC} versus Temp, $V_{CC} = 3\text{ V}$ and 5 V

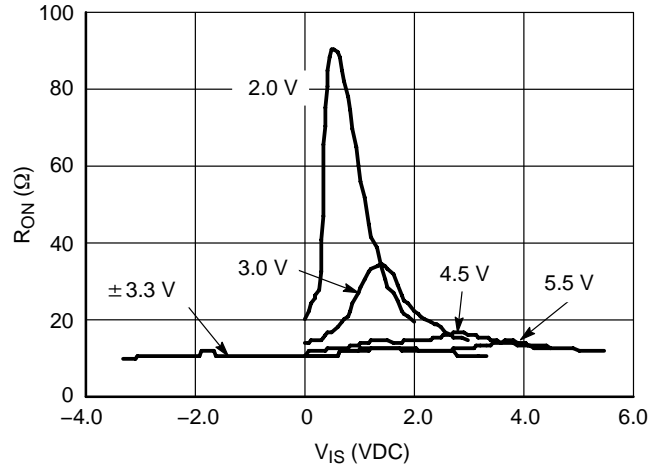

Figure 4. R_{ON} versus V_{CC} , Temp = 25°C

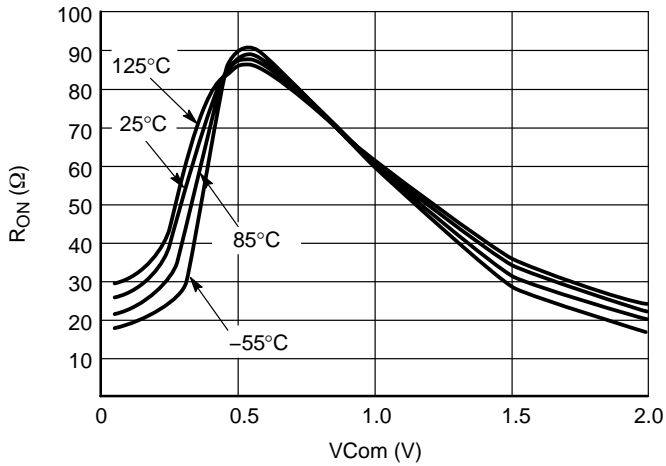

Figure 5. Typical On Resistance
 $V_{CC} = 2.0\text{ V}$, $V_{EE} = 0\text{ V}$

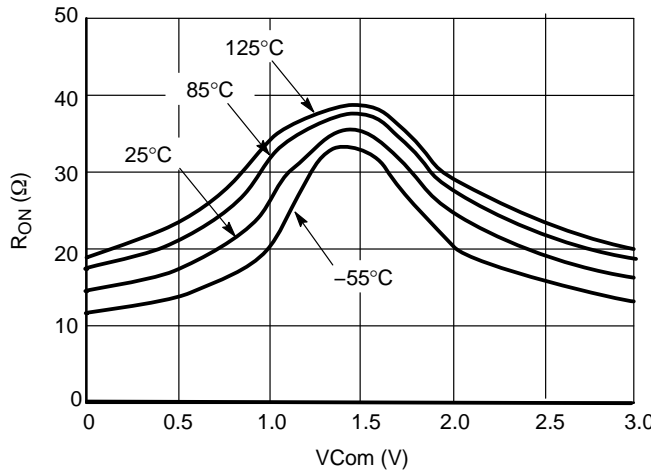

Figure 6. Typical On Resistance
 $V_{CC} = 3.0\text{ V}$, $V_{EE} = 0\text{ V}$

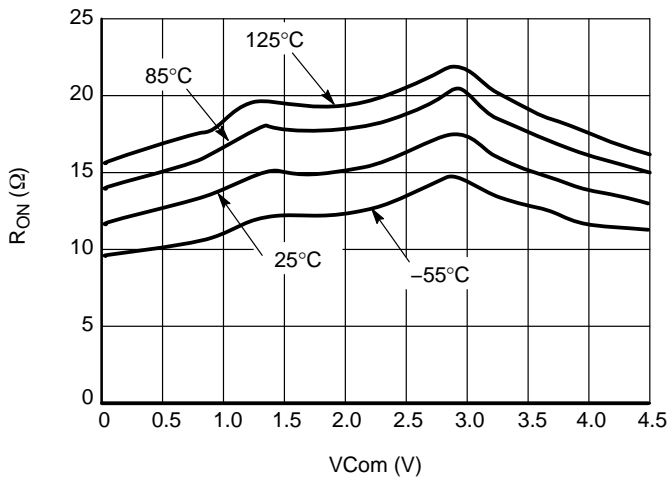

Figure 7. Typical On Resistance
 $V_{CC} = 4.5\text{ V}$, $V_{EE} = 0\text{ V}$

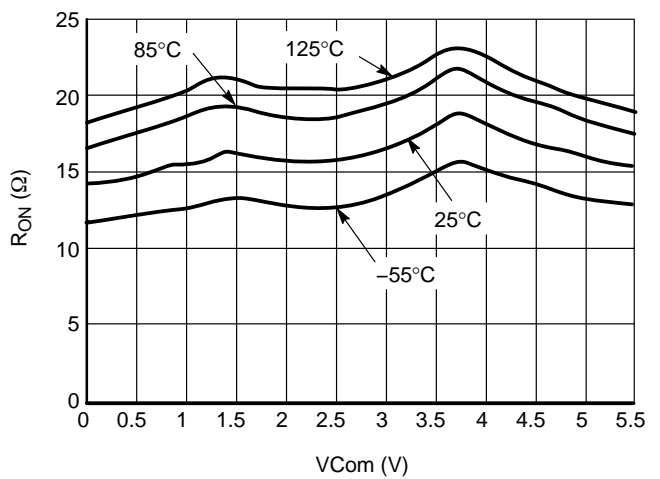

Figure 8. Typical On Resistance
 $V_{CC} = 5.5\text{ V}$, $V_{EE} = 0\text{ V}$

NLAS4053

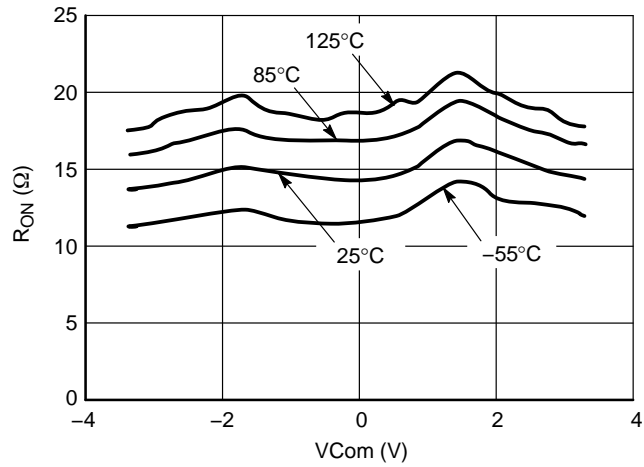

Figure 9. Typical On Resistance
 $V_{CC} = 3.3\text{ V}, V_{EE} = -3.3\text{ V}$

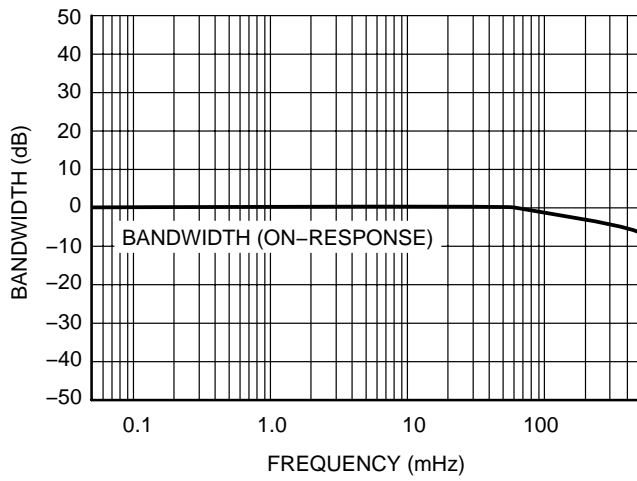

Figure 10. Bandwidth

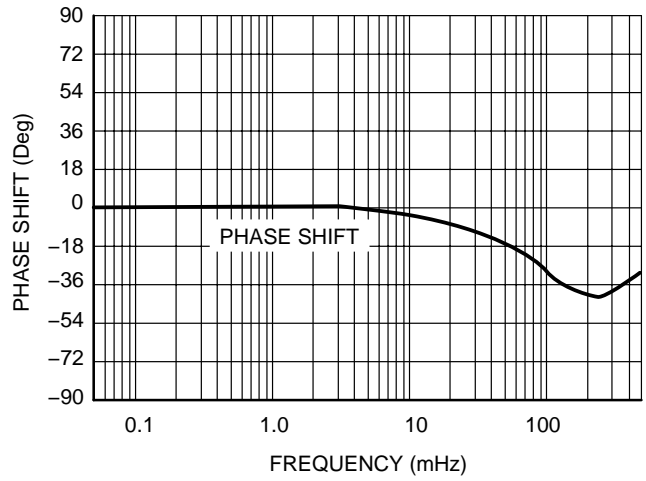

Figure 11. Phase Shift

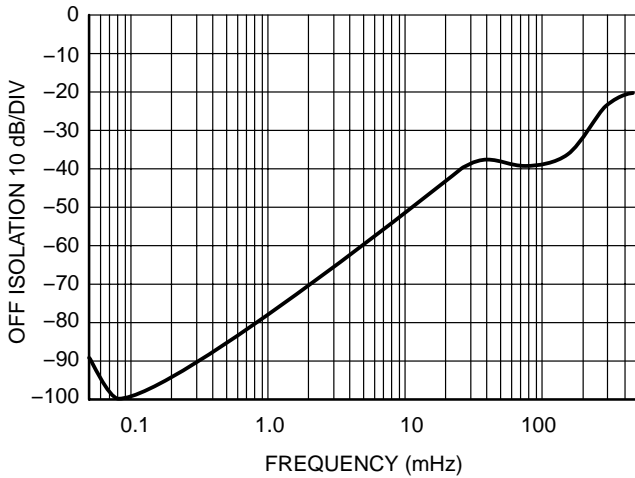

Figure 12. Off Isolation

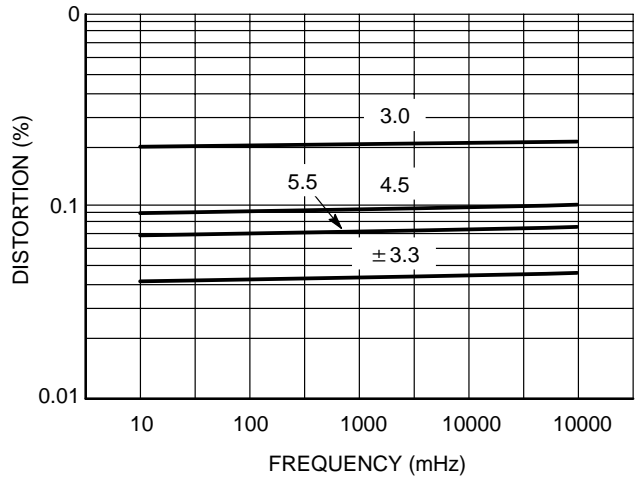

Figure 13. Total Harmonic Distortion

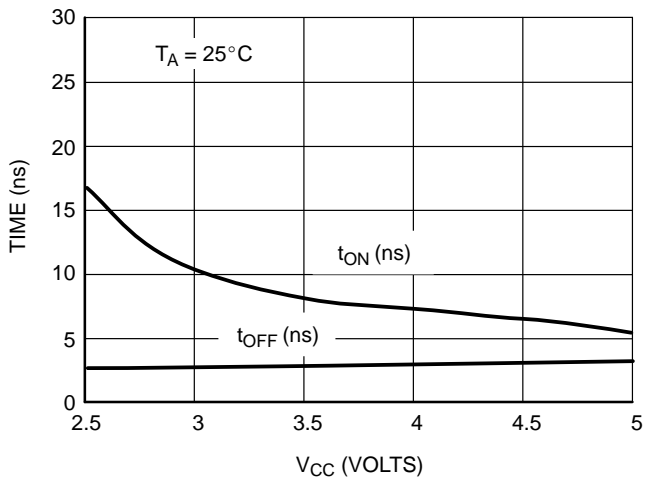

Figure 14. t_{ON} and t_{OFF} versus V_{CC}

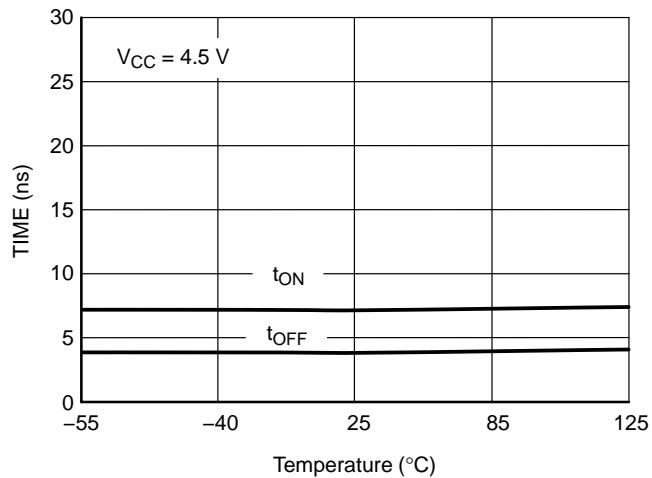

Figure 15. t_{ON} and t_{OFF} versus Temp

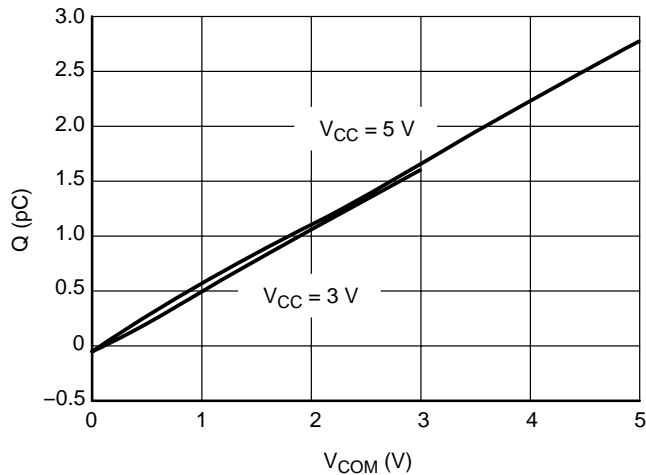

Figure 16. Charge Injection versus COM Voltage

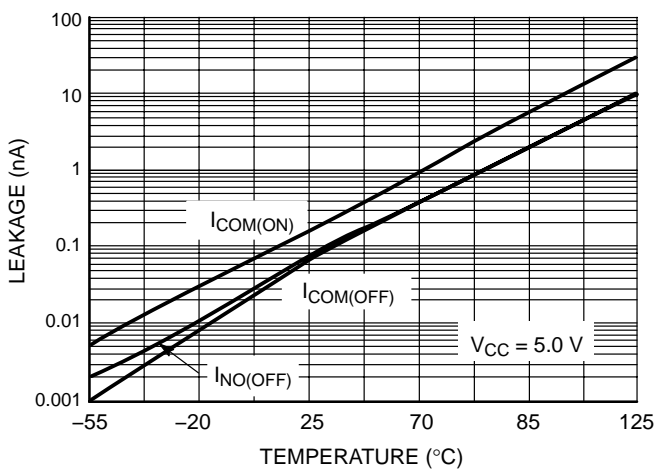

Figure 17. Switch Leakage versus Temperature

NLAS4053

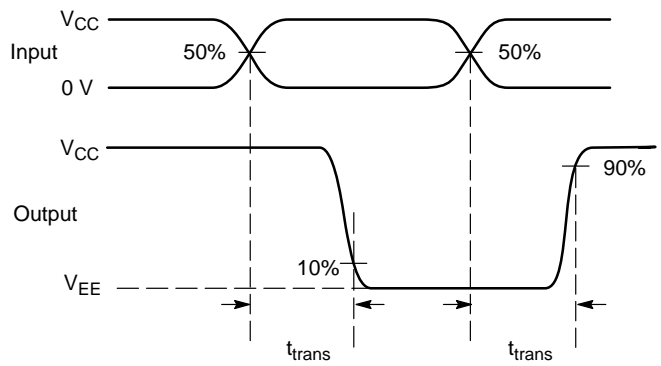
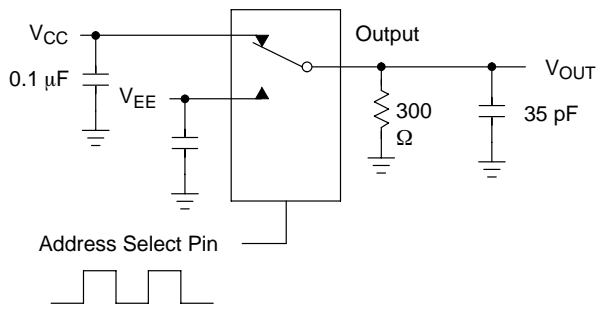

Figure 18. Channel Selection Propagation Delay

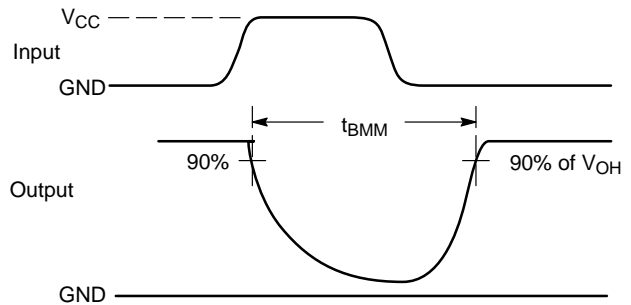
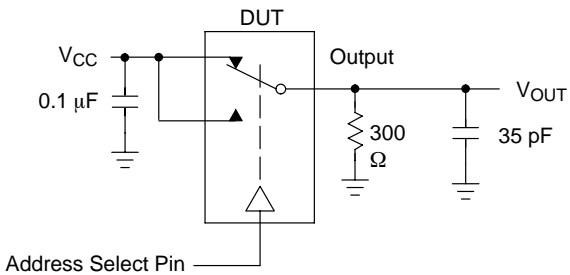

Figure 19. t_{BMM} (Time Break-Before-Make)

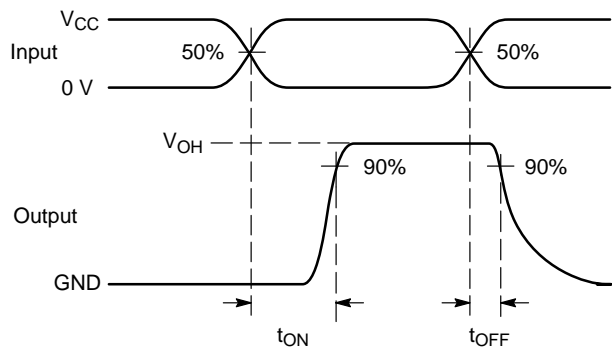
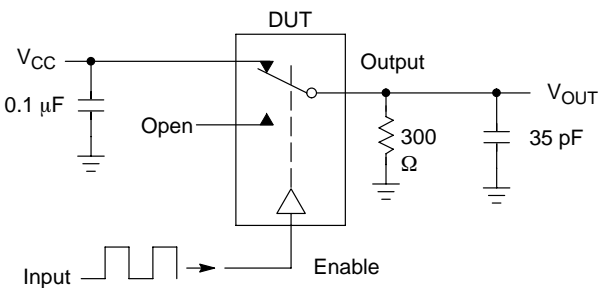

Figure 20. $t_{\text{ON}}/t_{\text{OFF}}$

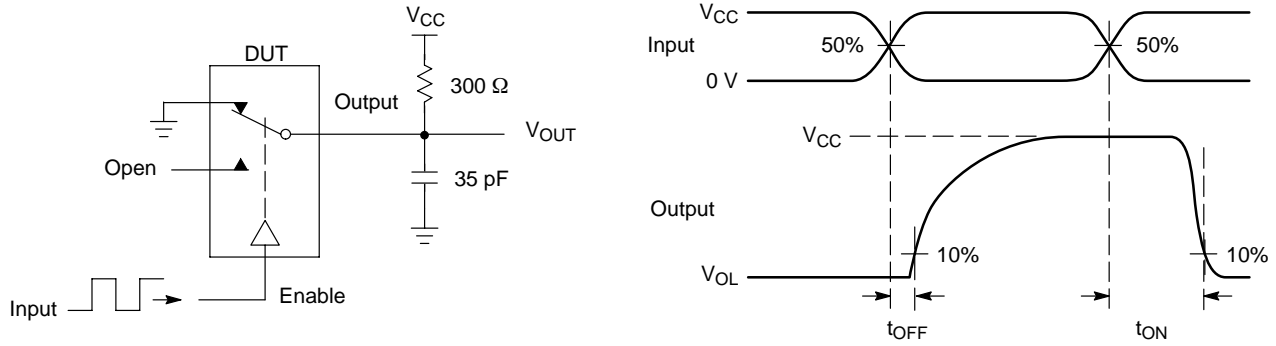
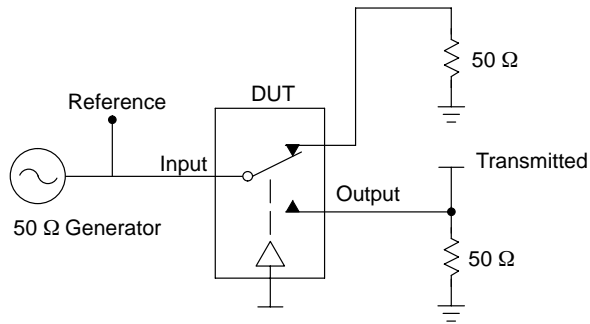

Figure 21. t_{ON}/t_{OFF}



Channel switch control/s test socket is normalized. Off isolation is measured across an off channel. On loss is the bandwidth of an On switch. V_{ISO} , Bandwidth and V_{ONL} are independent of the input signal direction.

$$V_{ISO} = \text{Off Channel Isolation} = 20 \text{ Log} \left(\frac{V_{OUT}}{V_{IN}} \right) \text{ for } V_{IN} \text{ at } 100 \text{ kHz}$$

$$V_{ONL} = \text{On Channel Loss} = 20 \text{ Log} \left(\frac{V_{OUT}}{V_{IN}} \right) \text{ for } V_{IN} \text{ at } 100 \text{ kHz to } 50 \text{ MHz}$$

Bandwidth (BW) = the frequency 3 dB below V_{ONL}

Figure 22. Off Channel Isolation/On Channel Loss (BW)/Crosstalk (On Channel to Off Channel)/ V_{ONL}

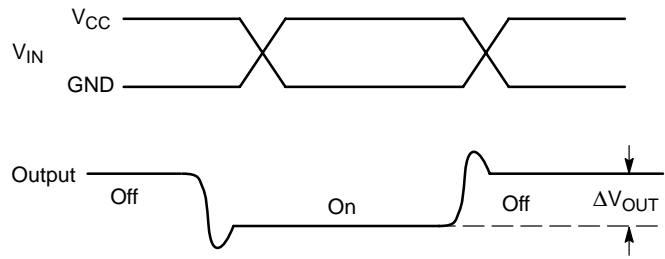
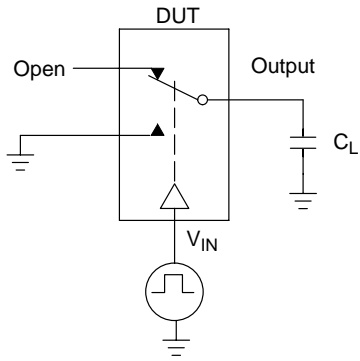

Figure 23. Charge Injection: (Q)

TYPICAL OPERATION

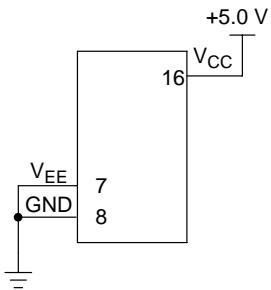

Figure 24. 5.0 Volts Single Supply
 $V_{CC} = 5.0 \text{ V}$, $V_{EE} = 0$

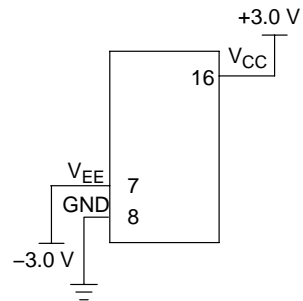
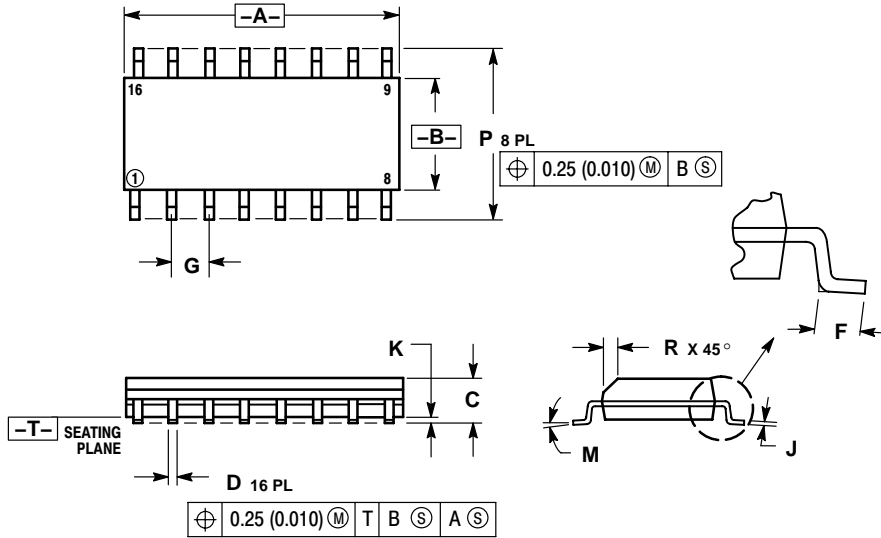

Figure 25. Dual Supply
 $V_{CC} = 3.0 \text{ V}$, $V_{EE} = -3.0 \text{ V}$

NLAS4053

PACKAGE DIMENSIONS

SOIC-16
D SUFFIX
CASE 751B-05
ISSUE J



NOTES:

1. DIMENSIONING AND TOLERANCING PER ANSI Y14.5M, 1982.
2. CONTROLLING DIMENSION: MILLIMETER.
3. DIMENSIONS A AND B DO NOT INCLUDE MOLD PROTRUSION.
4. MAXIMUM MOLD PROTRUSION 0.15 (0.006) PER SIDE.
5. DIMENSION D DOES NOT INCLUDE DAMBAR PROTRUSION. ALLOWABLE DAMBAR PROTRUSION SHALL BE 0.127 (0.005) TOTAL IN EXCESS OF THE D DIMENSION AT MAXIMUM MATERIAL CONDITION.

DIM	MILLIMETERS		INCHES	
	MIN	MAX	MIN	MAX
A	9.80	10.00	0.386	0.393
B	3.80	4.00	0.150	0.157
C	1.35	1.75	0.054	0.068
D	0.35	0.49	0.014	0.019
F	0.40	1.25	0.016	0.049
G	1.27 BSC		0.050 BSC	
J	0.19	0.25	0.008	0.009
K	0.10	0.25	0.004	0.009
M	0°	7°	0°	7°
P	5.80	6.20	0.229	0.244
R	0.25	0.50	0.010	0.019

NLAS4053

PACKAGE DIMENSIONS

TSSOP-16
DT SUFFIX
CASE 948F-01
ISSUE A

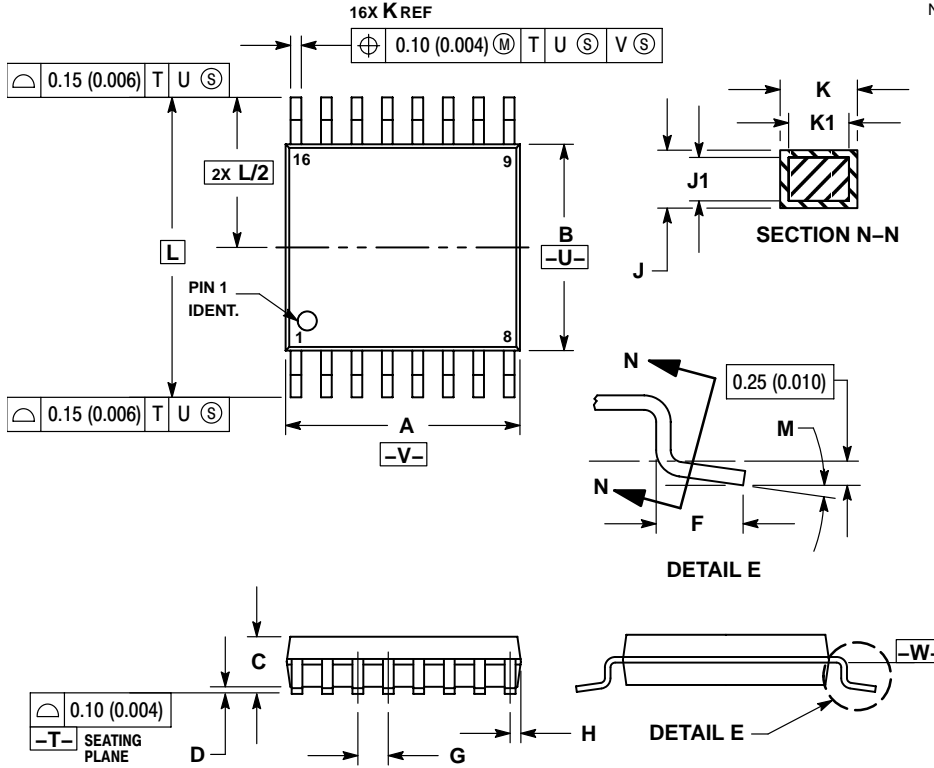

NOTES:

1. DIMENSIONING AND TOLERANCING PER ANSI Y14.5M, 1982.
2. CONTROLLING DIMENSION: MILLIMETER.
3. DIMENSION A DOES NOT INCLUDE MOLD FLASH, PROTRUSIONS OR GATE BURRS. MOLD FLASH OR GATE BURRS SHALL NOT EXCEED 0.15 (0.006) PER SIDE.
4. DIMENSION B DOES NOT INCLUDE INTERLEAD FLASH OR PROTRUSION. INTERLEAD FLASH OR PROTRUSION SHALL NOT EXCEED 0.25 (0.010) PER SIDE.
5. DIMENSION K DOES NOT INCLUDE DAMBAR PROTRUSION. ALLOWABLE DAMBAR PROTRUSION SHALL BE 0.08 (0.003) TOTAL IN EXCESS OF THE K DIMENSION AT MAXIMUM MATERIAL CONDITION.
6. TERMINAL NUMBERS ARE SHOWN FOR REFERENCE ONLY.
7. DIMENSION A AND B ARE TO BE DETERMINED AT DATUM PLANE -W-.

DIM	MILLIMETERS		INCHES	
	MIN	MAX	MIN	MAX
A	4.90	5.10	0.193	0.200
B	4.30	4.50	0.169	0.177
C	---	1.20	---	0.047
D	0.05	0.15	0.002	0.006
F	0.50	0.75	0.020	0.030
G	0.65 BSC		0.026 BSC	
H	0.18	0.28	0.007	0.011
J	0.09	0.20	0.004	0.008
J1	0.09	0.16	0.004	0.006
K	0.19	0.30	0.007	0.012
K1	0.19	0.25	0.007	0.010
L	6.40 BSC		0.252 BSC	
M	0°	8°	0°	8°

ON Semiconductor and  are registered trademarks of Semiconductor Components Industries, LLC (SCILLC). SCILLC reserves the right to make changes without further notice to any products herein. SCILLC makes no warranty, representation or guarantee regarding the suitability of its products for any particular purpose, nor does SCILLC assume any liability arising out of the application or use of any product or circuit, and specifically disclaims any and all liability, including without limitation special, consequential or incidental damages. "Typical" parameters which may be provided in SCILLC data sheets and/or specifications can and do vary in different applications and actual performance may vary over time. All operating parameters, including "Typicals" must be validated for each customer application by customer's technical experts. SCILLC does not convey any license under its patent rights nor the rights of others. SCILLC products are not designed, intended, or authorized for use as components in systems intended for surgical implant into the body, or other applications intended to support or sustain life, or for any other application in which the failure of the SCILLC product could create a situation where personal injury or death may occur. Should Buyer purchase or use SCILLC products for any such unintended or unauthorized application, Buyer shall indemnify and hold SCILLC and its officers, employees, subsidiaries, affiliates, and distributors harmless against all claims, costs, damages, and expenses, and reasonable attorney fees arising out of, directly or indirectly, any claim of personal injury or death associated with such unintended or unauthorized use, even if such claim alleges that SCILLC was negligent regarding the design or manufacture of the part. SCILLC is an Equal Opportunity/Affirmative Action Employer. This literature is subject to all applicable copyright laws and is not for resale in any manner.

PUBLICATION ORDERING INFORMATION

LITERATURE FULFILLMENT:

Literature Distribution Center for ON Semiconductor
P.O. Box 61312, Phoenix, Arizona 85082-1312 USA
Phone: 480-829-7710 or 800-344-3860 Toll Free USA/Canada
Fax: 480-829-7709 or 800-344-3867 Toll Free USA/Canada
Email: orderlit@onsemi.com

N. American Technical Support: 800-282-9855 Toll Free
USA/Canada

Japan: ON Semiconductor, Japan Customer Focus Center
2-9-1 Kamimeguro, Meguro-ku, Tokyo, Japan 153-0051
Phone: 81-3-5773-3850

ON Semiconductor Website: <http://onsemi.com>

Order Literature: <http://www.onsemi.com/litorder>

For additional information, please contact your
local Sales Representative.